

# Measuring transducer for frequency, input sinusoidal signal

- Straightforward application
- Suitable for severe operating conditions
- Compact construction
- Galvanic isolation between sensor input and output signal to the operating voltage
- Frequency ranges to suit customer requirements
- Provision made for fine adjustment of measuring range
- Anti-tamper seal for the fine adjustment
- Meet high EMC-requirements
- **CE** requirements
- Short-circuit-proof output selectable from  
0 ... 10 V/DC, 2 ... 10 V/DC, 0 ... 20 mA, 4 ... 20 mA
- Operating characteristics displayed by integrated LED
- Flame-inhibiting and self-extinguishing body
- Suitable tachogenerators are available (NORIS devices GE..)

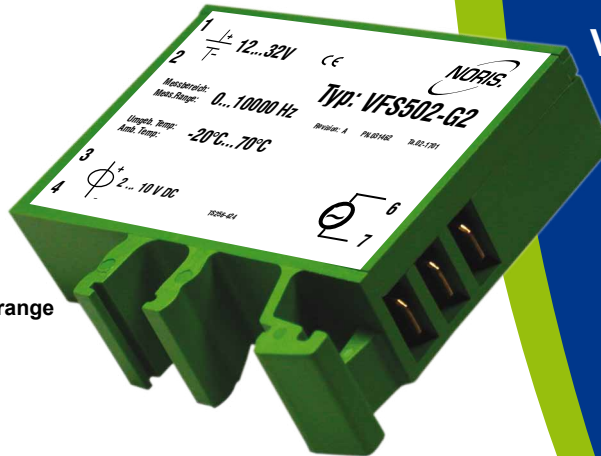

Image  
VFS502-G2



Germanischer Lloyd

## Measuring transducers of series 5

Measuring transducers of the Series 5 are designed to convert electric input values into standardised output signals.

Principle of operation: The transducer signal measured at the converter input is converted into a standardised output signal that is proportional to the input and lends itself to further customised processing, for instance, in a machine controller.

## General notes on Type VFS5.., VFG5..

### Description VFS5.., VFG5..

- Signal input for a sinusoidal frequency signal
- Suitable to evaluate outputs of speed pickups; AC-tacho-generators with various signal amplitudes
- Suitable to evaluate outputs of NORIS GE..-tacho-generator-series with VFG5..
- Input range: 0 ... 10.000 Hz (according to type)
- Maximum range frequency between: 50 ... 100 Hz (VFx500..), 100 ... 1.000 Hz (VFx501..), 1.000 ... 10.000 Hz (VFx502..) (Factory-set frequency adjustment)

To avoid triggering errors the frequency full range set in factory must be the highest frequency of the measuring chaîne.

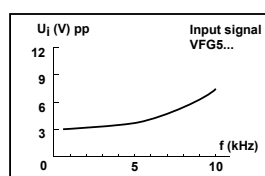
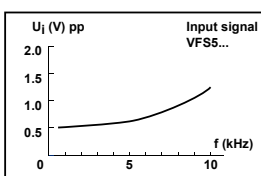

### Electric isolation

Sensor input and output signals are electrically isolated from the operating voltage. Multiple operation of amplifiers and evaluation devices is therefore possible at the same operating voltage. The sensor only supplies one amplifier device.

### Output signal

The output signal generated is a standardized voltage of 0 ... 10 V/DC or 2 ... 10 V/DC or, respectively, a standardized current of 0 ... 20 mA or 4 ... 20 mA. The output signal follows the input signal strictly linearly (deviation < 0.1%).

The output signal can be used to supply additional devices, such as indicating instruments and limit-value switches. Attention should be paid to the maximum driver capability of the output.

### Operating status display by LED

The green LED will be lit when the operating voltage is applied and the device is working normally.

## Technical Data

Series VFS5..., VFG5..	
Operating voltage	$U_o=9 \dots 32$ V/DC, $U_R=24$ V/DC
Ripple	$< 20\%$ $U_o$
Reverse voltage protection	Integrated
Overvoltage	2.5 times $U_R$ up to 2 ms
Voltage drops	100% up to 10 ms
Power consumption	Approx. 50 mA (24 V/DC)
Galvanic isolation	Between sensor input and output signal to the operating voltage
Input signal	Sinusoidal signal, NORIS tachogenerator GE
Input overloading	1.25 times input signal
Input resistance	VFS5.. approx. 10 k $\Omega$ , VFG5.. approx. 30 k $\Omega$
Output VFx5...-G.	0 ... 10 V/DC (VFx5...-G1), 2 ... 10 V/DC (VFx5...-G2), short-circuit-proof, load current 20 mA max.
Output VFx5...-I.	0 ... 20 mA (VFx5...-I1), 4 ... 20 mA (VFx5...-I2), load resistance 500 $\Omega$ max.
Noise voltage	Approx. 20 mV
Error class	IEC51-1 1.5%
Temperature sensitivity	$< \pm 0.1\%$ per 10 $^{\circ}$ K
Voltage sensitivity	$< \pm 0.1\%$ for 10% change in operating voltage
Load sensitivity	$< \pm 0.1\%$ for 50% change in load current
Reaction time	$f=50$ Hz / 0,25 s, $f=100$ Hz / 0,2 s, $f=1$ kHz / 0,1 s, $f=10$ kHz / 50 ms
Vibration resistance	IEC60068-T2-6 15g increased strain, characteristic 2 (10 ... 100 Hz)
Shock resistance (impact)	DIN IEC60068-T2-27 300 m/s <sup>2</sup> with 18 ms dwell time
Climatic test	IEC60068-T2-30
Operating temperature	-20 $^{\circ}$ C ... +70 $^{\circ}$ C
Storage temperature	-45 $^{\circ}$ C ... +85 $^{\circ}$ C
Humidity	RH 96% maximum
ESD	IEC61000-4-2 +/- 8 kV
Electromagnetic field	IEC61000-4-3 10 V/m $f=10$ kHz ... 2000 MHz, 80% AM @ 1 kHz 10 V/m $f=900$ +/- 5 MHz, 50% AM @ 200 Hz 10 V/m $f=1800$ MHz +/- 5 MHz, 50% AM @ 200 Hz
Burst	IEC61000-4-4 +/- 2 kV supply +/- 1 kV sensor
Surge	IEC61000-4-5 sym. +/- 1 kV ( $R_s=2$ $\Omega$ ) asym. +/- 2 kV ( $R_s=2$ $\Omega$ )
HF-susceptibility	IEC61000-4-6 3 V <sub>pp</sub> 80% AM @ 1 kHz $f=0.01$ ... 100 MHz
LF-susceptibility	IEC60553 3 V <sub>pp</sub> 0.05 ... 10 kHz
Interference field intensity	Basis CISPR 16-1, 16-2 reduced characteristic
Connection	DIN46244 flat connector, gold-plated A6.3 x 0.8
Protection class	DIN EN60529 Body IP20, terminals IP00
Mounting	Snap-fit on top-hat channel or G-channel
Installed position	Any
Body material	Thermoplastic polyester, green, fire protection class V0
Weight	55 g
Standard supply	CE requirements complied with, DIN EN 61000-6-2, DIN EN 61000-6-4, DIN EN 50155, approved by GL, BV, LR, DNV

## Other Data

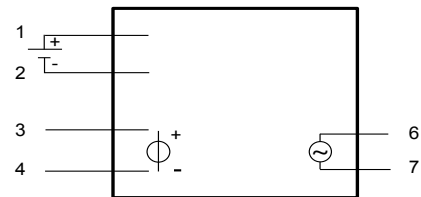
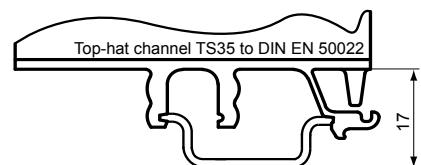
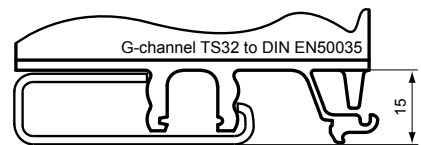
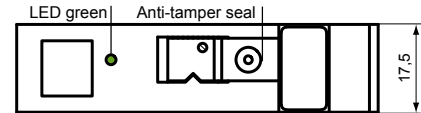
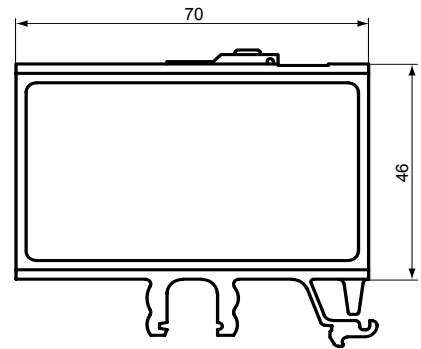

### LED code

x= LED lighting  
- = LED out  
o= LED flashing

	LED green
Operating	x

## Type key / variants

Frequency version:	00	01	02
Output: 0 ... 10 V/DC	VFx500-G1	VFx501-G1	VFx502-G1
Output: 2 ... 10 V/DC	VFx500-G2	VFx501-G2	VFx502-G2
Output: 0 ... 20 mA	VFx500-I1	VFx501-I1	VFx502-I1
Output: 4 ... 20 mA	VFx500-I2	VFx501-I2	VFx502-I2

replace x with input signal range S or G  
Please state upper range frequency in case of order  
(10 V/DC or 20 mA meets the ordered input frequency)

### Device codes

V	Measuring transducer
Input signal	
FS	Frequency input for sinusoidal signal 1 V <sub>pp</sub> ... 10 V <sub>pp</sub>
FG	Frequency input for sinusoidal signal 6 V <sub>pp</sub> ... 200 V <sub>pp</sub> , NORIS-tachogenerators GE
Type series	
5	Type 5
Input range $f_B$ / upper-range frequency $f_E$	
00	$f_B$ : 10 ... 100 Hz, $f_E$ : 50 ... 100 Hz
01	$f_B$ : 20 ... 1.000 Hz, $f_E$ : 100 ... 1.000 Hz
02	$f_B$ : 200 ... 10.000 Hz, $f_E$ : 1.000 ... 10.000 Hz
Variants	
- G1	Output 0 ... 10 V/DC, short-circuit-proof
- G2	Output 2 ... 10 V/DC, short-circuit-proof
- I1	Output 0 ... 20 mA
- I2	Output 4 ... 20 mA
Maximum range frequency	
- ...	Maximum range frequency in Hz (= 20 mA bzw. 10 V)

V FS 5 01 -I2 -352 (VFS501-I2-352) order example

**NORIS**  
AUTOMATION

NORIS Automation GmbH  
Muggenhofer Str. 95  
90429 Nuremberg  
Germany

Tel.: +49 911 3201-220  
Fax: +49 911 3201-150  
sales@noris-group.com  
www.noris-group.com