

Limit-value switch for frequency, input automotive alternator

- Straightforward application
- Suitable for severe operating conditions
- Compact construction
- No additional supply voltage required
- Limit value freely adjustable by drum scale
- Anti-tamper seal for drum scale
- Provision made for fine adjustment of measuring range
- Meet high EMC-requirements **CE** requirements
- Volt-free output as normally closed contact or normally open contact
- Open-circuit or closed-circuit variants available
- Open-circuit devices with integrated push button to simulate an increased sensor signal for test functions without critical machine loading
- Optionally with latching function (only open circuit devices)
- Operating characteristics displayed by integrated LEDs
- Flame-inhibiting and self-extinguishing body

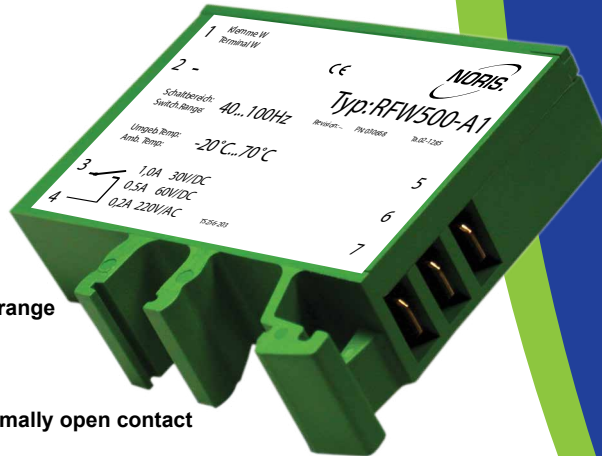

Image RFW500-A1



Germanischer Lloyd

Limit-value switches of series 5

Limit value switches of the series 5 are designed to monitor and process electric measured variables.

Working principle: When the actual value of the measuring signal supplied reaches the setpoint, the built-in relay will operate. The switching status of the relay contact may, for instance, be monitored or individually processed by a machine controller.

General notes on Type RFW5..

Description RFW5..

The Type RFW5.. is designed for monitoring a frequency signal of an automotive alternator. The terminal W supplies a pulsating DC-voltage from a coil winding of the alternator with subsequent rectification. There is no signal at standstill. Above a predetermined speed level, a voltage is generated and available as a pulsating DC-voltage of approx. 26 V/DC. Evaluation of this voltage is frequency-oriented. The voltage at the same time provides the supply voltage for the limit-value switch. The frequency range is obtained automatically and there is no need for calibration. The minimum range is the no-load speed of the alternator of approx. 1,500 rpm at approx. 150 Hz. The maximum range is dictated by the maximum speed of the prime mover of approx. 12,000 rpm at approx. 1,200 Hz. Access is provided to a trimming potentiometer for subsequent adjustments of the measuring range. Settings of the limit value are made at the short top side of the device by means of a drum scale graduated in per cent. The maximum speed of the prime mover defines 100%. Settings can be at any value between 20 - 100%. In selecting the limit value it is important to take into consideration any step-up/step-down ratios between the prime mover and the alternator. No switching functions are provided below the no-load speed.

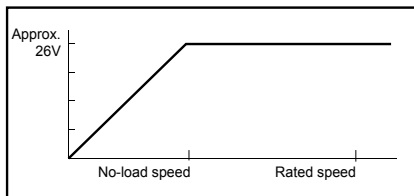

To avoid triggering errors the frequency full range set in factory must be the highest frequency of the measuring chaine, the set point will be done in a ratio to the full range.

Test function for open circuit devices

Open-circuit devices have an integrated test button. As long as this button is kept pressed, the preselected limit value is decreased by approx. 15%. This enables safety functions, such as an overspeed trip to be tested without running the machine in the critical range.

Volt-free relay contact, closed-circuit or open-circuit version

A volt-free relay contact is provided as a normally closed or normally open contact for outputting and further processing. In addition, there is a choice between closed-circuit and open-circuit devices.

In the case of closed-circuit devices, the output relay is pulled up in the normal state of operation with the supply voltage applied. It drops off upon the limit-value being exceeded or if the supply voltage fails.

In the open-circuit variant, the output relay pulls up when the limit-value is exceeded with the supply voltage applied. Failure of the voltage will not result in any switching function below the limit value.

Latching function for open circuit devices

Open circuit devices can optionally be equipped with a latching function (see type code). When the limit value is exceeded, the relay keeps activated even if the signal falls below the limit value afterwards. The device has to be reset by disconnecting the supply voltage.

Technical Data

Series RFW5..	
Supply voltage	U_s supply from terminal W
Ripple	-
Reverse voltage protection	Integrated
Overvoltage	2.5 times U_R up to 2 ms
Voltage drops	-
Power consumption	Approx. 70 mA (24 V/DC)
Galvanic isolation	Between input signal and supply voltage
Input signal	Terminal W of a 24 V automotive alternator
Input overloading	$< U_R$
Output contact	Volt-free NOC or NCC, closed circuit or open circuit
Maximal switching capacity	30 W (1 A at 30 V/DC; 0.5 A at 60 V/DC) 40 W (0.2 A at 220 V/AC)
Limit value	Adjustable on tamper-proof drum scale between 20 ... 100%
Reproducibility	$< +/- 0.2\%$
Linearity of scale	$< +/- 1.5\%$
Hysteresis	Approx. 2% (1,5% for RFX502-devices)
Test button function	Limit value lowered by approx. 15% (only open- circuit devices)
Error class	IEC51-1 1.5%
Temperature sensitivity	$< +/- 0.1\%$ je $10\text{ }^\circ\text{K}$
Voltage sensitivity	$< +/- 0.1\%$ for 10% change in supply voltage
Reaction time	$f=50\text{ Hz} / 0,25\text{ s}$, $f=100\text{ Hz} / 0,2\text{ s}$, $f=1\text{ kHz} / 0,1\text{ s}$, $f=10\text{ kHz} / 50\text{ ms}$
Vibration resistance	IEC60068-T2-6 15g increased strain, characteristic 2 (10 ... 100 Hz)
Shock resistance (impact)	DIN IEC60068-T2-27 300 m/s ² with 18 ms dwell time
Climatic test	IEC60068-T2-30
Operating temperature	$-20\text{ }^\circ\text{C} \dots +70\text{ }^\circ\text{C}$
Storage temperature	$-45\text{ }^\circ\text{C} \dots +85\text{ }^\circ\text{C}$
Humidity	RH 96% maximum
ESD	IEC61000-4-2 +/- 8 kV
Electromagnetic field	IEC61000-4-3 10 V/m $f=10\text{ kHz} \dots 2000\text{ MHz}$, 80% AM @ 1 kHz 10 V/m $f=900 \pm 5\text{ MHz}$, 50% AM @ 200 Hz 10 V/m $f=1800\text{ MHz} \pm 5\text{ MHz}$, 50% AM @ 200 Hz
Burst	IEC61000-4-4 +/- 2 kV supply +/- 1 kV sensor
Surge	IEC61000-4-5 sym. +/- 1 kV ($R_f=2\text{ }\Omega$) asym. +/- 2 kV ($R_f=2\text{ }\Omega$)
HF-susceptibility	IEC61000-4-6 3 V _{pp} 80% AM @ 1 kHz $f=0.01 \dots 100\text{ MHz}$
LF- susceptibility	IEC60553 3 V _{pp} 0.05 ... 10 kHz
Interference field intensity	Basis CISPR 16-1, 16-2 reduced characteristic
Connection	DIN46244 flat connector, gold-plated A6.3 x 0.8
Protection class	DIN EN60529 Body IP20, terminals IP00
Mounting	Snap-fit on top-hat channel or G-channel
Installed position	Any
Body material	Thermoplastic polyester, green, fire protection class V0
Weight	55 g
Applied standards	CE requirements complied with, DIN EN 61000-6-2, DIN EN 61000-6-4, DIN EN 50155, approved by GL, BV, LR, DNV

Type key / variants

Device codes

R	Limit-value switch
Input signal	
FW	Frequency input for a terminal W of a 24 V automotive alternator
Type series	
5	Type 5
Input range	
00	0 ... 100 Hz
01	0 ... 1,000 Hz
02	0 ... 10,000 Hz
Variants	
R1	Output contact as NCC in closed current
R2	Output contact as NOC in closed current
A1	Output contact as NCC in open-circuit current
A2	Output contact as NOC in open-circuit current
S1	Output contact as NCC in open-circuit current with latching function
S2	Output contact as NOC in open-circuit current with latching function

R FW 5 01 - A2 (RFW501-A2) order example

Other Data

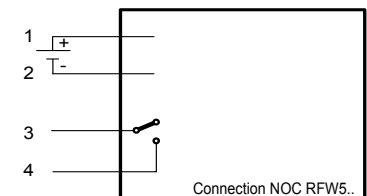
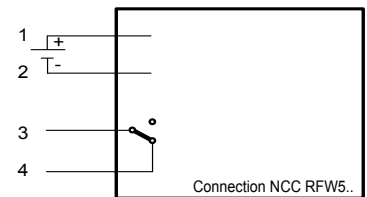
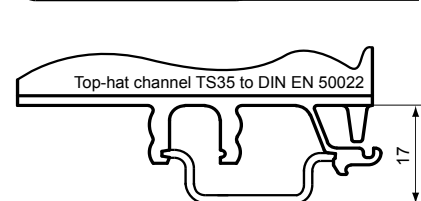
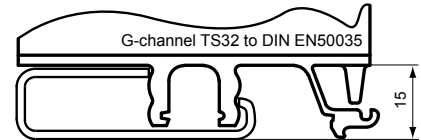
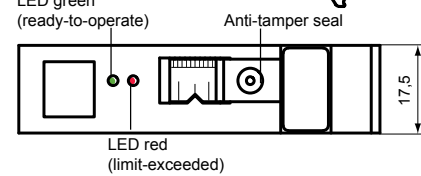
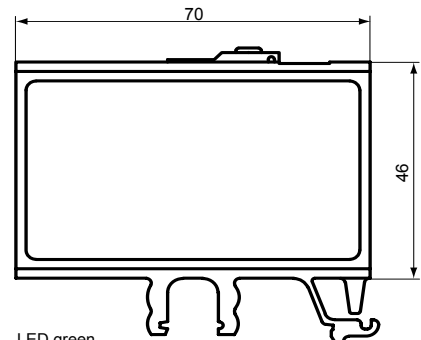

Relay position

	RFW5..-R1	RFW5..-R2	RFW5..-A1	RFW5..-A2	RFW5..-S1	RFW5..-S2
f < limit value	-	x	x	-	x	-
f > limit value	x	-	-	x	- (*)	x (**)

x = contact closed

- = contact open

(*) = Latching function: as -A1, but relay keeps open until U_s is disconnected

(**) = Latching function: as -A2, but relay keeps closed until U_s is disconnected

The red LED is illuminated, if the limit value is exceeded



NORIS Automation GmbH
Muggenhofer Strasse 95
90429 Nuremberg
Germany

Tel.: +49 911 3201-220
Fax: +49 911 3201-150
sales@noris-group.com
www.noris-group.com